



LuckyLight

5mm Round With Flange Type
Infrared LED
Technical Data Sheet

Part No.: 503SIR

Features:

- ◇ Standard T-1 3/4 diameter package.
- ◇ Low forward voltage.
- ◇ Infrared Emitting Diode.
- ◇ Viewing angle =45°.
- ◇ Reliable and rugged.
- ◇ The product itself will remain within RoHS complaint Version.

Descriptions:

- ◇ The device is spectrally matched with silicon photodiode and phototransistor.

Applications:

- ◇ Floppy disk drive.
- ◇ Optoelectronic switch.
- ◇ Camera.
- ◇ VCR.
- ◇ Video.
- ◇ Smoke detector.
- ◇ Infrared applied system.
- ◇ Free air transmission system.
- ◇ Infrared remote control units.

Package Dimension:

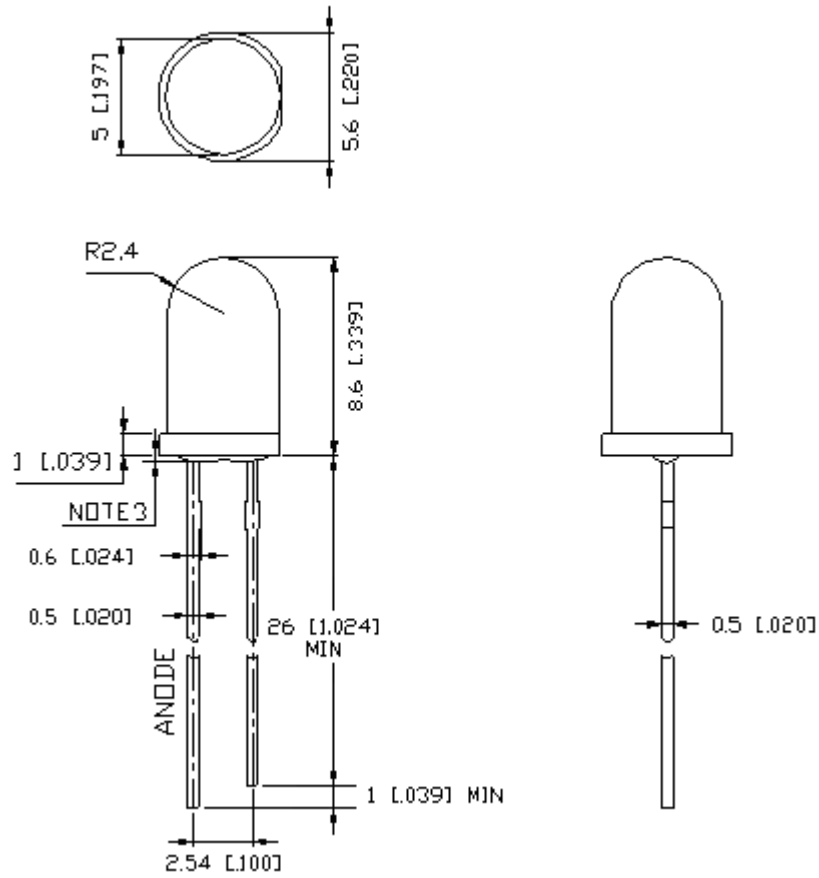

Part No.	Material	Lens Color	Source Color
503SIRC	GaAlAs	Water Clear	Infrared

Notes:

1. All dimensions are in millimeters (inches).
2. Tolerance is ± 0.25 (.010") unless otherwise specified.
3. Protruded resin under flange is 1.00mm(.039") max.
4. Specifications are subject to change without notice.

Absolute Maximum Ratings at Ta=25°C

Parameters	Symbol	Max.	Unit
Power Dissipation	PD	165	mW
Peak Forward Current (1/10 Duty Cycle, 0.1ms Pulse Width)	IFP	1	A
Forward Current	IF	100	mA
Reverse Voltage	VR	5	V
Operating Temperature Range	Topr	-40°C to +85°C	
Storage Temperature Range	Tstg	-40°C to +100°C	
Soldering Temperature	Tsld	260°C for 5 Seconds	

Electrical Optical Characteristics at Ta=25°C

Parameters	Symbol	Min.	Typ.	Max.	Unit	Test Condition
Radiant Intensity	Ee	10.0	16.0	---	mW/sr	IF =20mA
Viewing Angle*	2θ _{1/2}	---	45	---	Deg	(Note 1)
Peak Emission Wavelength	λ _p	---	850	---	nm	IF=20mA
Spectral Bandwidth	Δλ	---	45	---	nm	IF=20mA
Forward Voltage	VF	1.00	1.45	1.65	V	IF =20mA
Reverse Current	IR	---	---	10	μA	VR=5V

Notes:

1. θ_{1/2} is the off-axis angle at which the luminous intensity is half the axial luminous intensity.

Typical Electrical / Optical Characteristics Curves
(25°C Ambient Temperature Unless Otherwise Noted)

Fig.1 Forward Current vs. Ambient Temperature

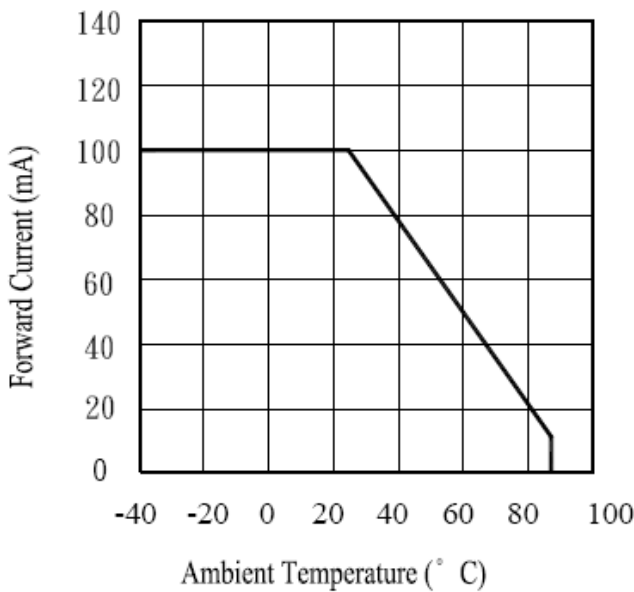

Fig.2 Spectral Distribution

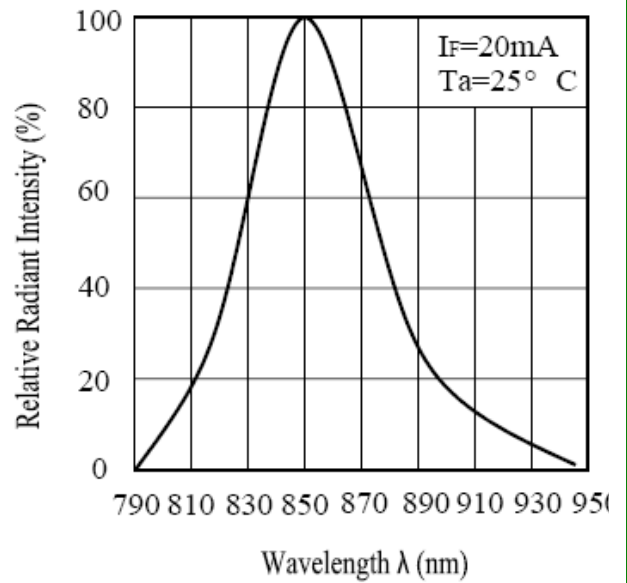

Fig.3 Peak Emission Wavelength vs. Ambient Temperature

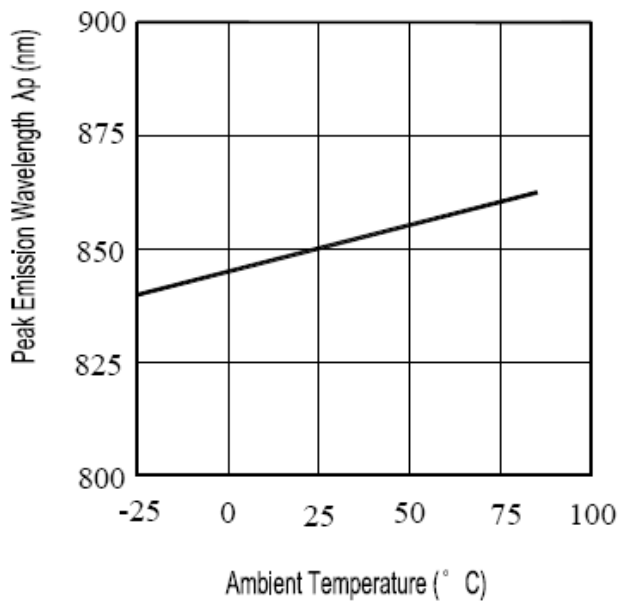

Fig.4 Forward Current vs. Forward Voltage

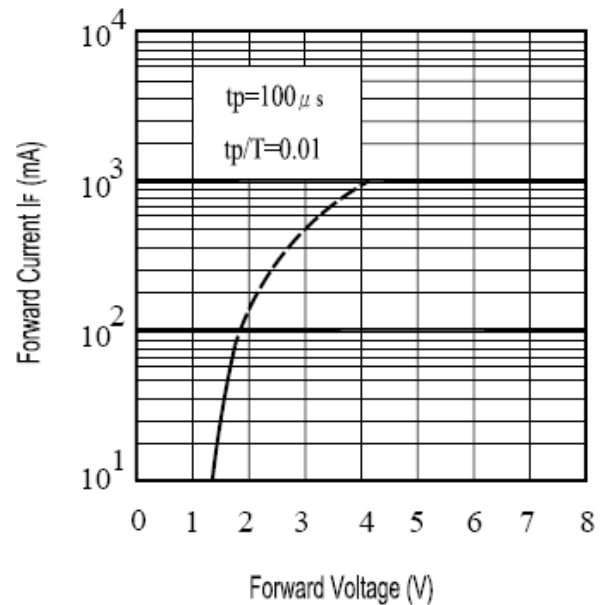



Fig.5 Relative Intensity vs. Forward Current

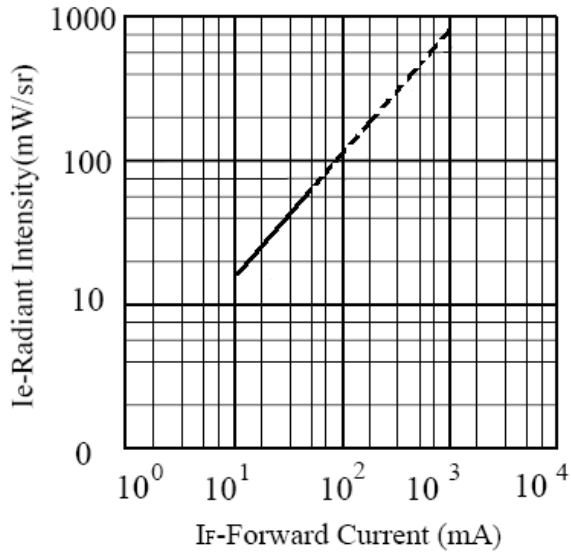

Fig.6 Relative Radiant Intensity vs. Angular Displacement

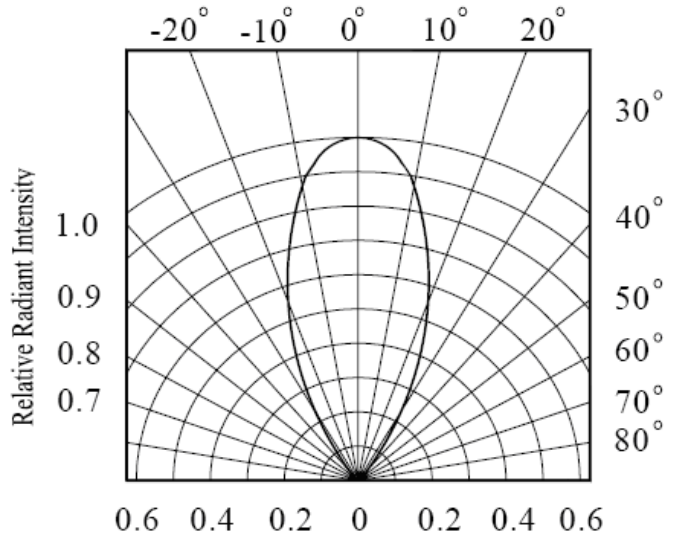

Fig.7 Radiant Intensity vs. Ambient Temperature($^\circ$ C)

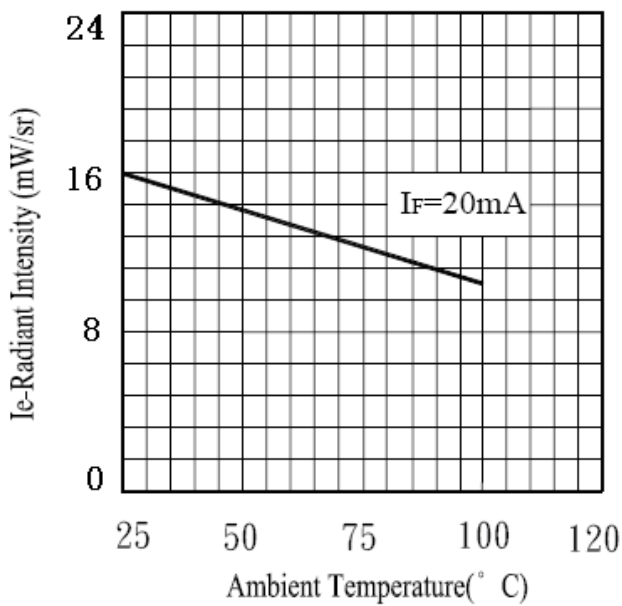
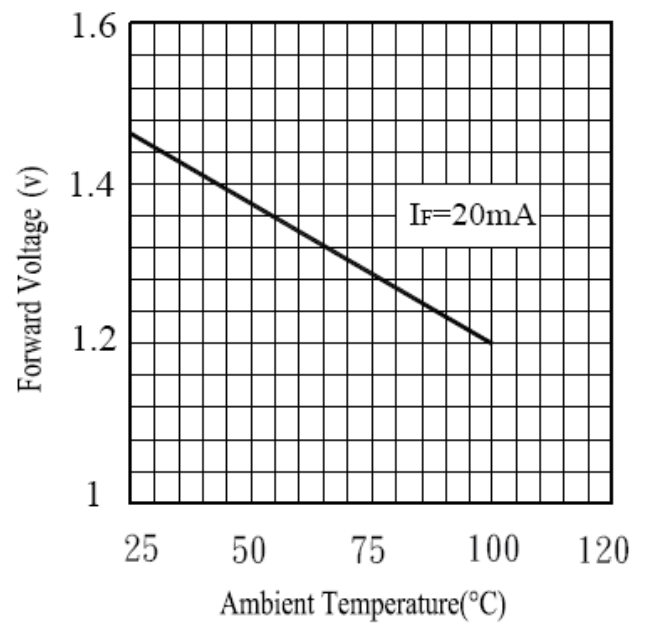

Fig.8 Forward Voltage vs. Ambient Temperature($^\circ$ C)



Reliability Test Items And Conditions:

The reliability of products shall be satisfied with items listed below:

Confidence level: 90%.

LTPD: 10%.

1) Test Items and Results:

No.	Test Item	Test Hours/Cycles	Test Conditions	Sample Size	Ac/Re
1	Resistance to Soldering Heat	6 Min	Tsld=260±5°C, Min. 5sec	25pcs	0/1
2	Thermal Shock	300 Cycles	H:+100°C 5min∫ 10 sec L:-10°C 5min	25pcs	0/1
3	Temperature Cycle	300 Cycles	H:+100°C 15min∫5min L:-40°C 15min	25pcs	0/1
4	High Temperature Storage	1000Hrs.	Temp:100°C	25pcs	0/1
5	DC Operating Life	1000Hrs.	If=20mA	25pcs	0/1
6	Low Temperature Storage	1000Hrs.	Temp:-40°C	25pcs	0/1
7	High Temperature / High Humidity	1000Hrs.	85°C/85%RH	25pcs	0/1

2) Criteria for Judging The Damage:

Item	Symbol	Test Conditions	Criteria for Judgment	
			Min	Max
Forward Voltage	VF	IF=20mA	—	F.V.*)×1.1
Reverse Current	IR	VR=5V	—	F.V.*)×2.0

*) F.V.: First Value.